

GENERAL BUILDING DATA:

ITEMS	FEET
WIDTH:	24'-0"
LENGTH:	24'-0"
EAVE HEIGHT:	14'-0" *
ROOF PITCH:	4" *
FRAME SPACING:	12'-0" ** *
RAFTER SPACING:	2'-0" ** *
GIRT SPACING:	2'-0" ** *

DESIGN CRITERIA

ITEMS	UNIT
WIND SPEED	80 MPH (FASTEST MILD 95 MPH (5 SEC. GUST))
EXPOSURE	B
SEISMIC ZONE	D
DEAD LOAD	5 psf
SOIL BEARING	1500 psf

GENERAL NOTES

THE GENERAL CONTRACTOR SHALL VERIFY ALL DIMENSIONS AND SITE CONDITIONS BEFORE STARTING WORK. THE OWNER/CONTRACTOR SHALL NOTIFY THE BUILDING CODE DIVISION OF ANY DESCRIPTIONS, CHANGES, OMISSIONS OR SUBSTITUTIONS ARE NOT PERMITTED WITHOUT THE APPROVAL OF THE BUILDING DEPARTMENT HAVING JURISDICTION. ALL WORKMANSHIP SHALL CONFORM TO OREGON STRUCTURAL SPECIALTY CODE.

THE STRUCTURE IS DESIGNED TO FUNCTION AS A UNIT UPON COMPLETION . THE CONTRACTOR/OWNER IS RESPONSIBLE FOR METHODS AND SEQUENCES OF ASSEMBLING THE STRUCTURE. THE CONTRACTOR/OWNER IS RESPONSIBLE FOR THE STABILITY OF THE STRUCTURE DURING THE CONSTRUCTION AND PRIOR TO COMPLETION OF ALL WALLS, ROOF AND FLOOR DIAPHRAGMS

DRILLED FOUNDATION

THE FOOTING SHALL BEAR ON NATIVE, INORGANIC, UNDISTURBED NATIVE SOIL BELOW EXISTING GRADE. ALL STRUCTURAL FOOTINGS SHALL BE EXTENDED MINIMUM 4'-0" BELOW FINISHED GRADE UNLESS NOTED OTHERWISE ON PLANS. THERE SHALL BE 95% COMPACTION OF ALL BACKFILL FOR SLAB ON GRADE IN ACCORDANCE OF ASTM D 1557 MODIFIED PROCTOR DENSITY.

BACK FILL IN THE ANNULAR SPACE AROUND THE POSTS SHALL BE BY ONE OF THE FOLLOWING METHODS:

- A. CONCRETE WITH THE ULTIMATE STRENGTH OF MIN. 2000 PSI.
- B. CLEAN SAND: THE SAND SHALL BE COMPACTED BY TAMPING IN **LAYERS NOT MORE THAN 6" IN DEPTH**
- C. GRANULAR BACKFILL: THE GRANULAR BACKFILL SHALL BE 3/4 (4) GRAVEL OR CRASHED ROCK. BACKFILL SHALL BE COMPACTED BY TAMPING IN LAYERS NOT MORE THAN 6" IN DEPTH.
- D. NO SPECIAL INSPECTION FOR COMPACTION BY TAMPING

WOOD

STRUCTURAL LUMBER SHALL CONFORM TO WESTERN SOUTHWOOD ASSOCIATION FOR GRADING.

- POSTS SHALL BE 6 X P.T.H#2 U.N.O
- POSTS SHALL BE PRESSURE TREATED TO 0.60 Pcf RETENTION CCA ACCORDANCE WITH UBC STD 25-12 AND A.W.P.A.JP-44.
- POSTS SHALL BE CENTERED ON THE FOOTING.
- GIRTS SHALL BE 2 X 6 DPF2 @ 24" O.C. U.N.O
- RAFTERS SHALL BE 2 X 6 DPF2 @ 24" O.C. U.N.O

FASTENERS, ANCHORS AND CONNECTORS

- BOLTS SHALL BE 3/4 DIAMETER MACHINE BOLTS WITH WASHERS AND NUTS AND SHALL CONFORM TO ASTM.
- WHERE BOLTS COME INTO CONTACT WITH PRESSURE TREATED WOOD WHEN CHROMONITE IS USED THEY SHALL BE GALVANIZED STEEL.
- NUTS FOR BOLTS SHALL BE EITHER CROWN NUTS OR NYLON LOCKNUTS AND SHALL BE TIGHTENED TO THE APPROPRIATE MANUFACTURERS RECOMMENDATIONS.
- NAILS IN TREATED WOOD SHALL BE HOT DIPPED GALVANIZED

GIRT TO POST RAFTER TO BLOCKING BLOCKING TO TRUSSES (NAILS AT EACH SIDE U.N.O)	(3) 16d
---	---------

- * SPECIFIED EAVE HEIGHT IS MAXIMUM HEIGHT. PLANS AND DETAILS ARE ADEQUATE FOR HEIGHTS LESS THAN 14'-0"
- * * SPECIFIED ROOF PITCH IS MAXIMUM. PLANS AND DETAILS ARE ADEQUATE FOR ROOF PITCH LESS THAN 4 TO 12
- * * * SPECIFIED FRAME SPACING IS MAXIMUM. PLANS AND DETAILS ARE ADEQUATE FOR SPACING LESS THAN 12'-0". SEE 1/310 FOR TRUSSES BRACING FOR OPENING GREATER THAN 14'-0"

BUILDING CODES DIVISION

1535 EDGEWATER STREET NW
SALMON OR 97306
P.O. BOX 14470
TEL: (503) 378-4133 FAX: (503) 378-2322

READY BUILT PLAN #2014-01
PREScriptive POST FRAME BUILDING
24'-0" X 24'-0" X 14'-0"

WIND: 95 MPH EXPOSURE "B"
SNOW: 30 PSF

BUILDING CODE:

OSSC: 2010

Sheet:

S01

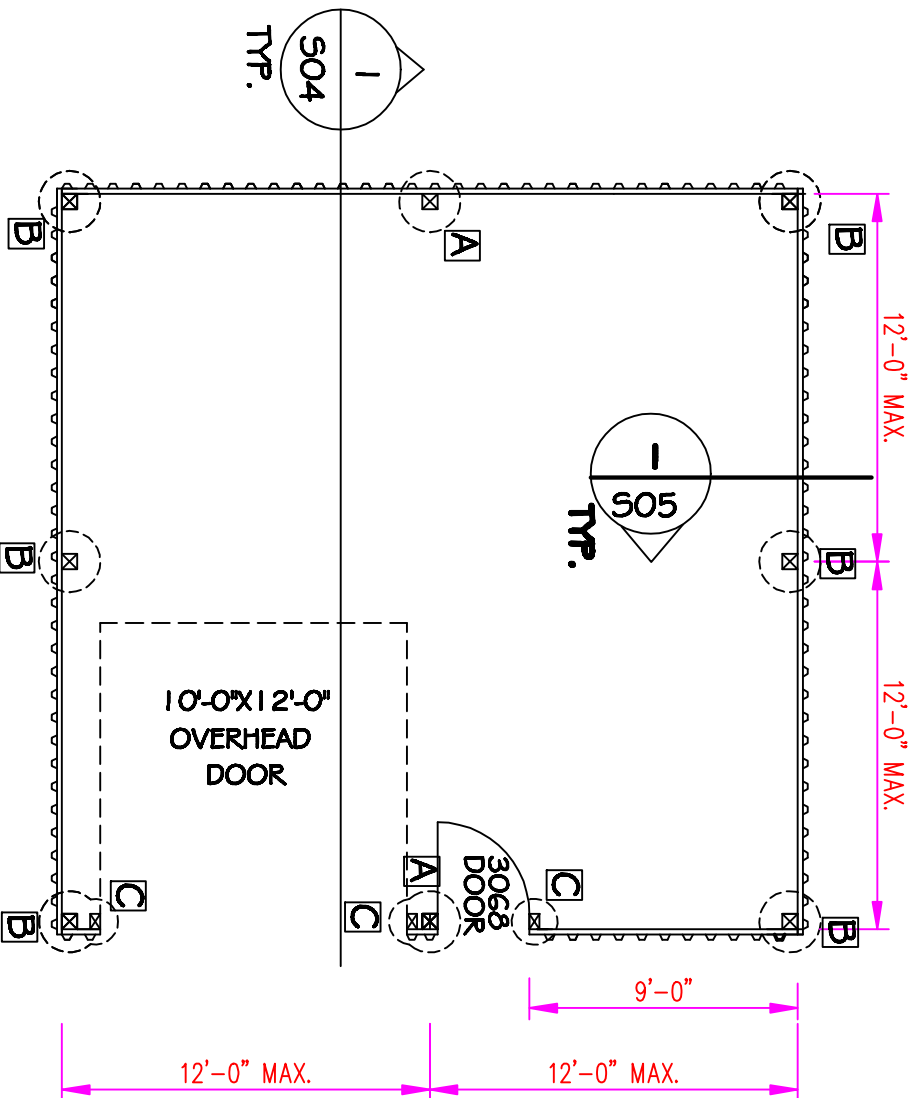

POST	POST SIZE	HOLE DIA (IN)	HOLE DEPTH (IN)	REMARKS
A	P.T 6X6 HF#2	24	54	SEE DETAIL 2/509
B	P.T 6X6 HF#2	24	54	SEE DETAIL 2/509
C	P.T 6X6 HF#2	24	54	SEE DETAIL 2/509

1 FOUNDATION/ FLOOR PLAN

502

BUILDING CODES DIVISION

1535 EDGEWATER STREET NW
 SALISBURY OR 97306
 P.O. BOX 14470
 TEL: (503) 378-4133 FAX: (503) 378-2322

READY BUILD PLAN #2014-01

PRESCRIPTIVE POST FRAME BUILDING
 24'-0" X 24'-0" X 14'-0"
 WIND: 95 MPH EXPOSURE "B"
 SNOW: 30 PSF

BUILDING CODE:

OSBC: 2010

Sheets:

S02

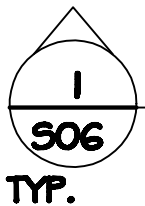
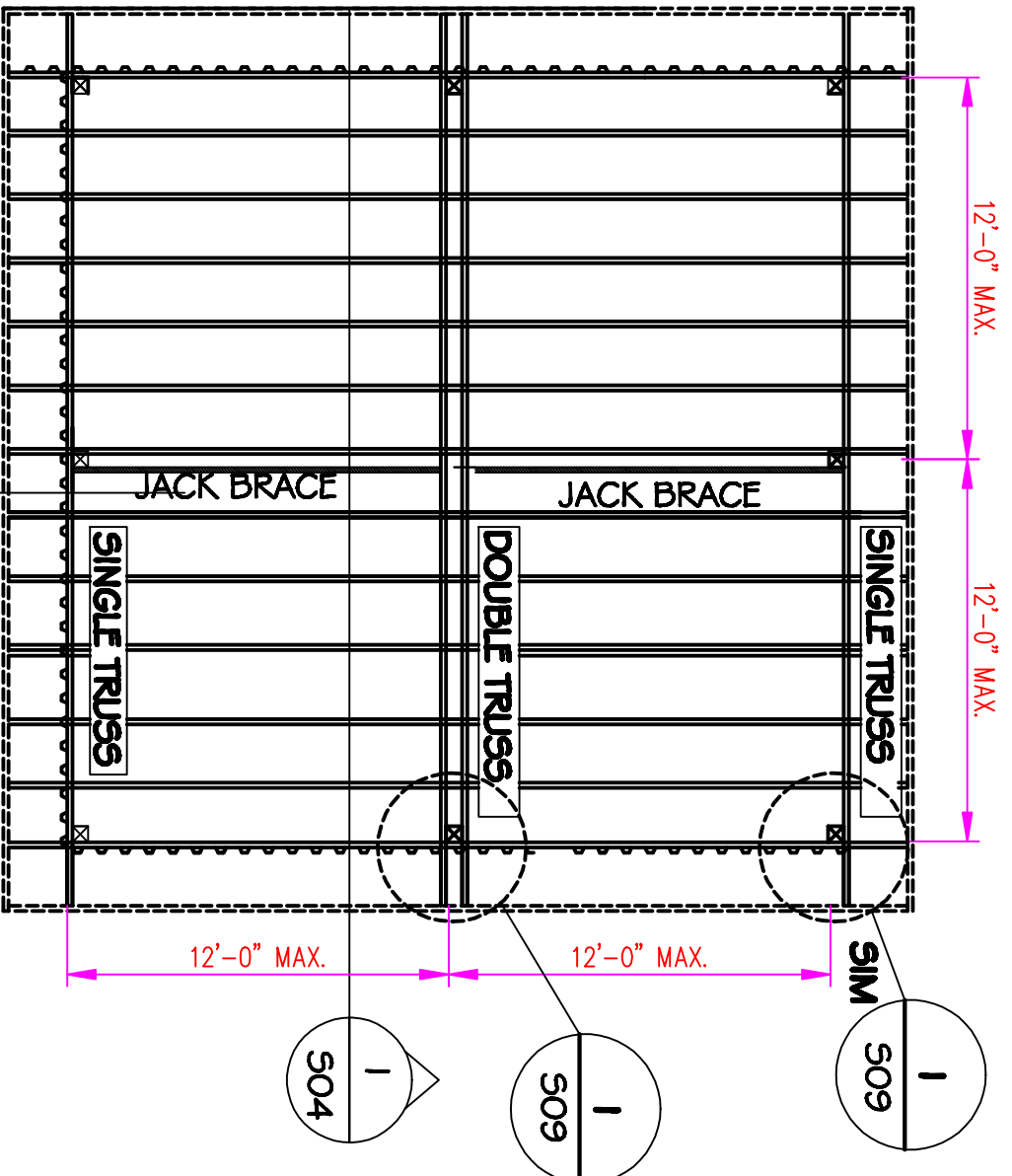

PLAN NOTES:

1. 2X6 DF#2 @ 24" O.C TYPICAL RAFTERS
2. 7/16" OSB W/8d@6" O.C EDGES AND 12" O.C FIELD (OPTIONAL)
3. 15# FELT
4. 29 GAGE METAL ROOF SHEATHING PER S10
5. MAX. 2'-0" OVERHANG (OPTIONAL)

1
S03

ROOF FRAMING PLAN

BUILDING CODES DIVISION

1535 EDGEWATER STREET NW
SALMON CR 97306
P.O. BOX 14470
TEL: (503) 378-4133 FAX: (503) 378-2322

READY BUILT PLAN #2014-01
PREScriptive POST FRAME BUILDING
24'-0" X 24'-0" X 14'-0"

WIND: 95 MPH EXPOSURE "B"
SNOW: 30 PSF

BUILDING CODE:

OSBC: 2010

Sheets:

S03

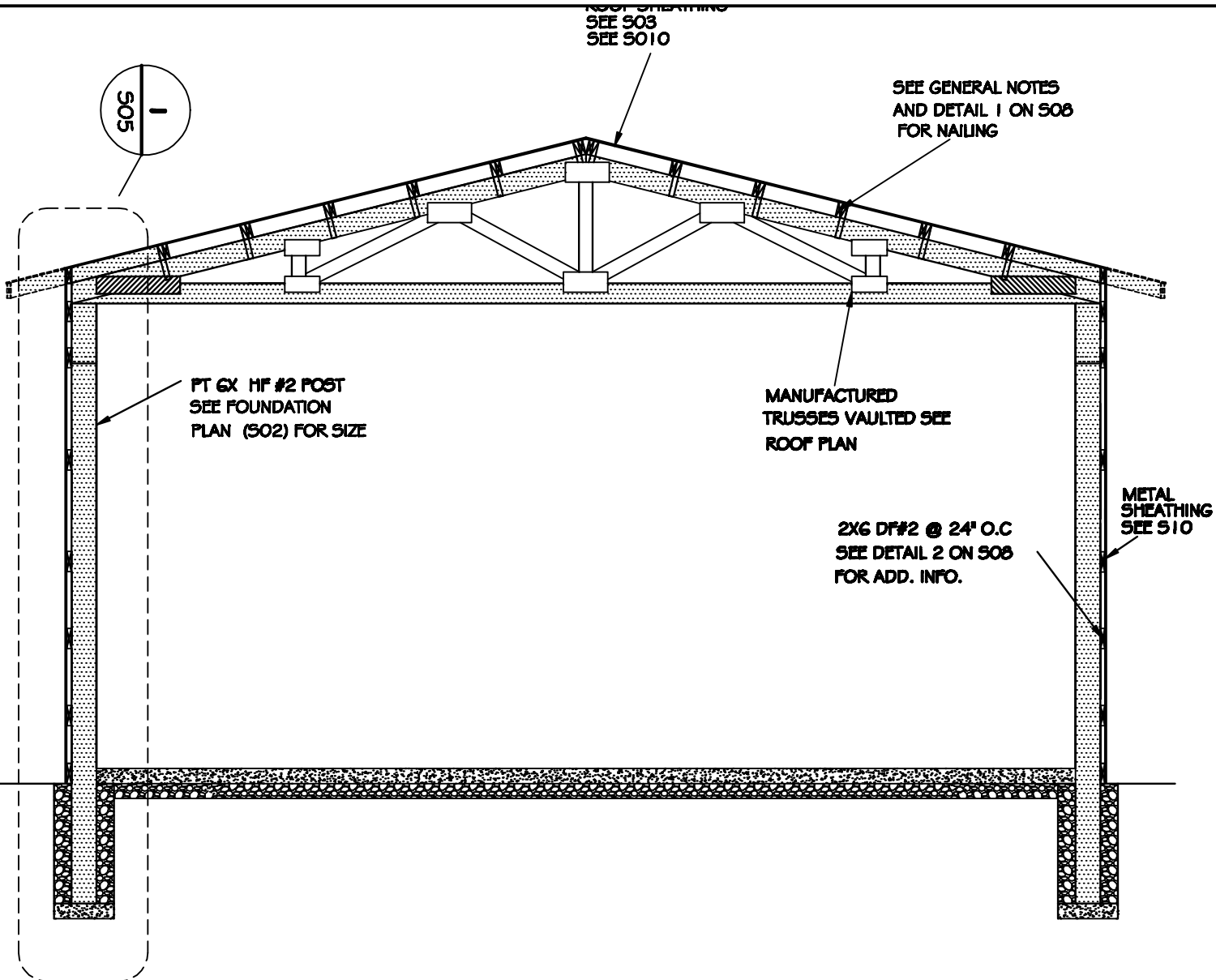

1
TYPICAL BUILDING SECTION
504

BUILDING CODES DIVISION
 1535 EDGEWATER STREET NW
 SALMON OR 97306
 P.O. BOX 14470
 TEL: (503) 378-4133 FAX: (503) 378-2322

READY BUILT PLAN #2014-01
 PRESCRIPTIVE POST FRAME BUILDING
 24'-0" X 24'-0" X 14'-0"
 WIND: 95 MPH EXPOSURE "B"
 SNOW: 30 PSF

BUILDING CODE:
 OMSC: 2010

Sheet:
 S04

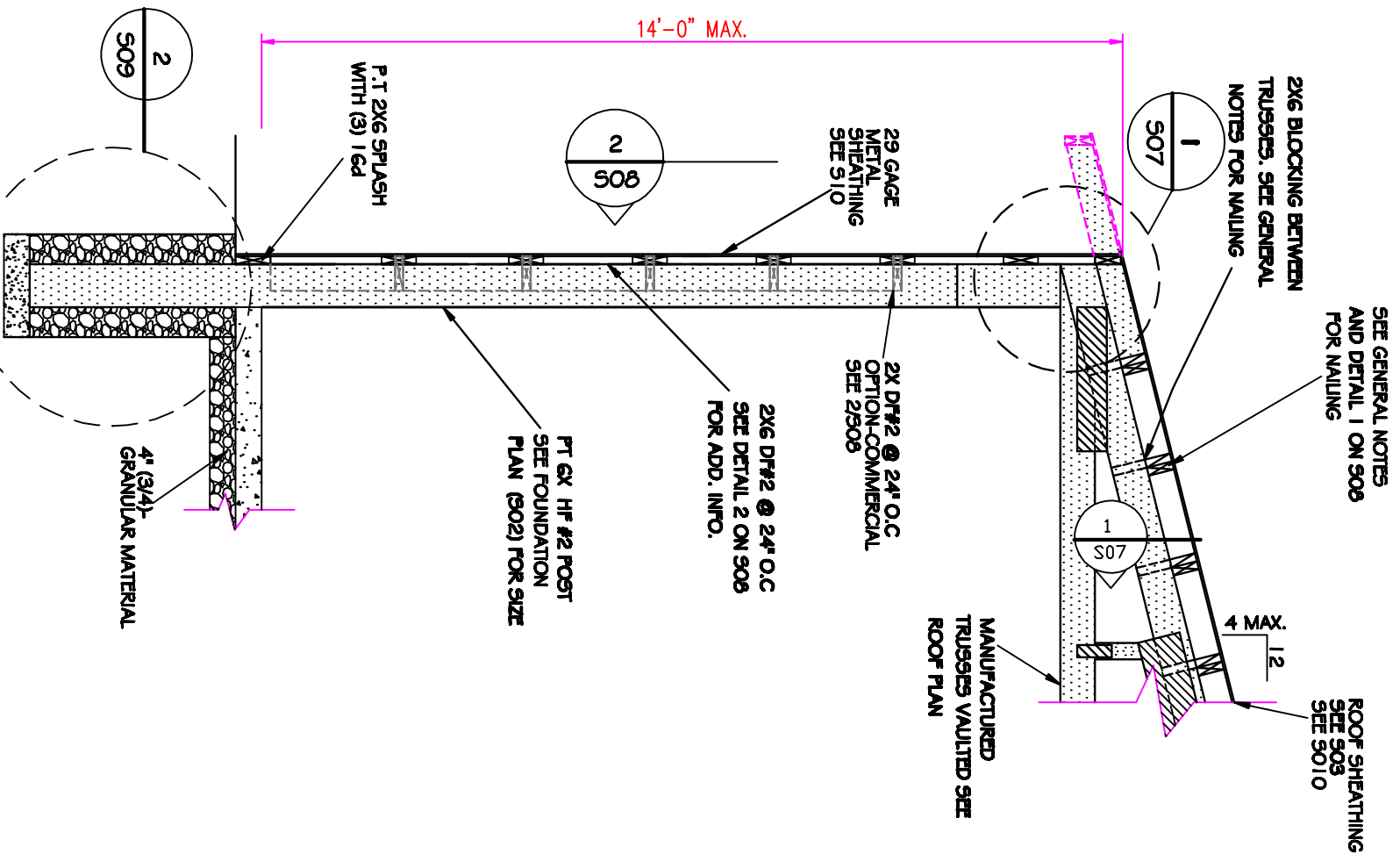

1 TYPICAL FRAME SECTION/ SIDE WALL

S05

N.T.S

BUILDING CODES DIVISION
 1535 EDGEWATER STREET NW
 SALISBURY OR 97306
 P.O. BOX 14470
 TEL: (503) 378-4133 FAX: (503) 378-2322

READY BUILD PLAN #2014-01
 PRESCRIPTIVE POST FRAME BUILDING
 24'-0" X 24'-0" X 14'-0"
 WIND: 95 MPH EXPOSURE "B"
 SNOW: 30 PSF

BUILDING CODE:
 O55C: 2010

Sheets:
S05

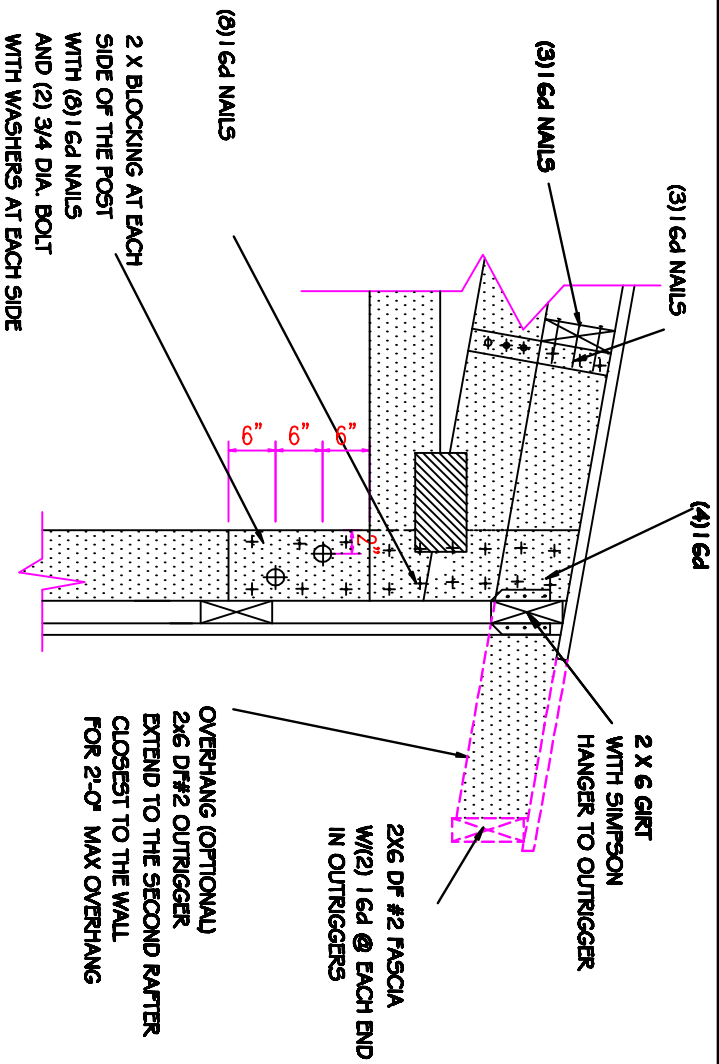

1
S07
TRUSS TO POST CONNECTION DETAIL

SEE I/S07 FOR
ADD. INFORMATION
ON THE OUTRIGGERS

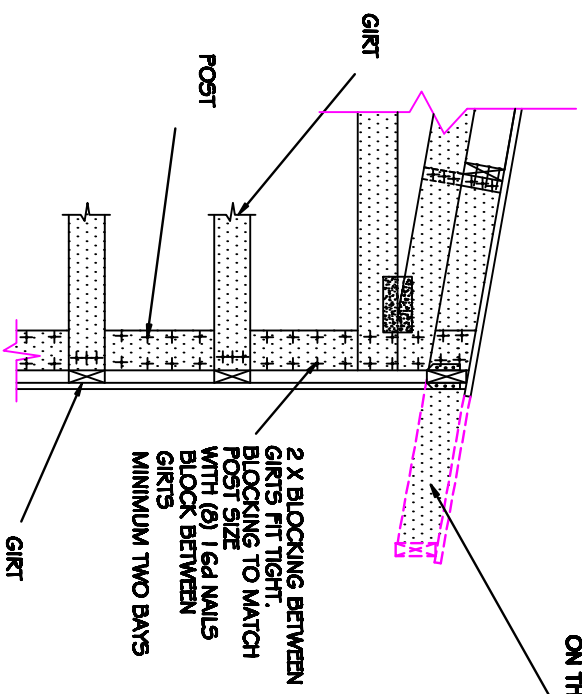

2
S07
GABLE END WALL TRUSS CONNECTION

BUILDING CODES DIVISION
1535 EDGEWATER STREET NW
SALSBY OR 97306
P.O. BOX 14470
TEL: (503) 378-4133 FAX: (503) 378-2322

READY BUILT PLAN #2014-01
PREScriptive POST FRAME BUILDING
24'-0" X 24'-0" X 14'-0"
WIND: 95 MPH EXPOSURE "B"
SNOW: 30 PSF

BUILDING CODE:
OS5C: 2010

Sheet:
S07

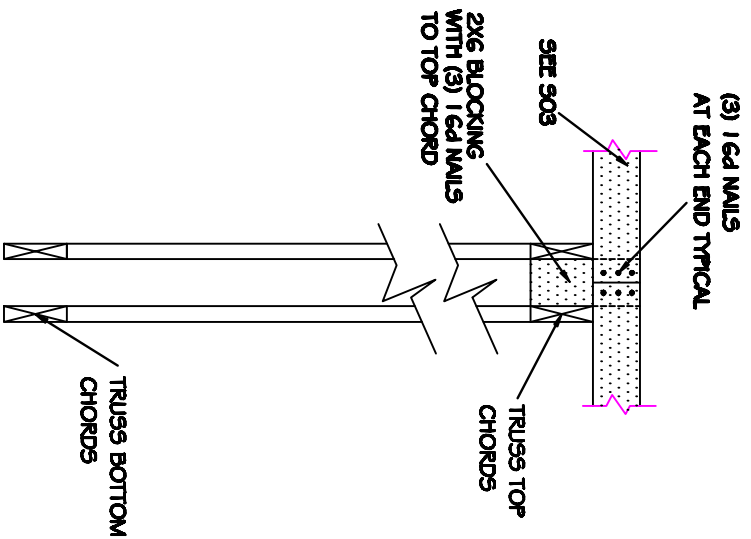

1 TYPICAL PURLIN TO TRUSS CONNECTION DETAIL
508

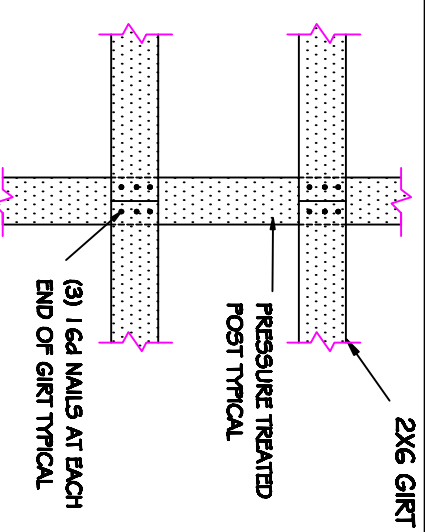

OPTION WITH COMMERCIAL GIRT

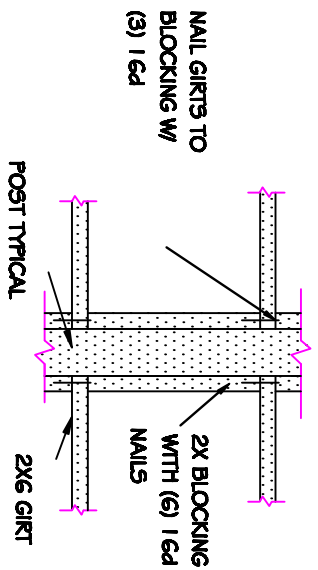

2 GIRT TO POST CONNECTION DETAIL
508

BUILDING CODES DIVISION

1535 EDGEWATER STREET NW
SALMON OR 97306
P.O. BOX 14470
TEL: (503) 378-4133 FAX: (503) 378-2322

READY BUILT PLAN #2014-01

PRESCRIPTIVE POST FRAME BUILDING
24'-0" X 24'-0" X 14'-0"
WIND: 95 MPH EXPOSURE "B"
SNOW: 30 PSF

BUILDING CODE:

OSBC: 2010

Sheet:

S08

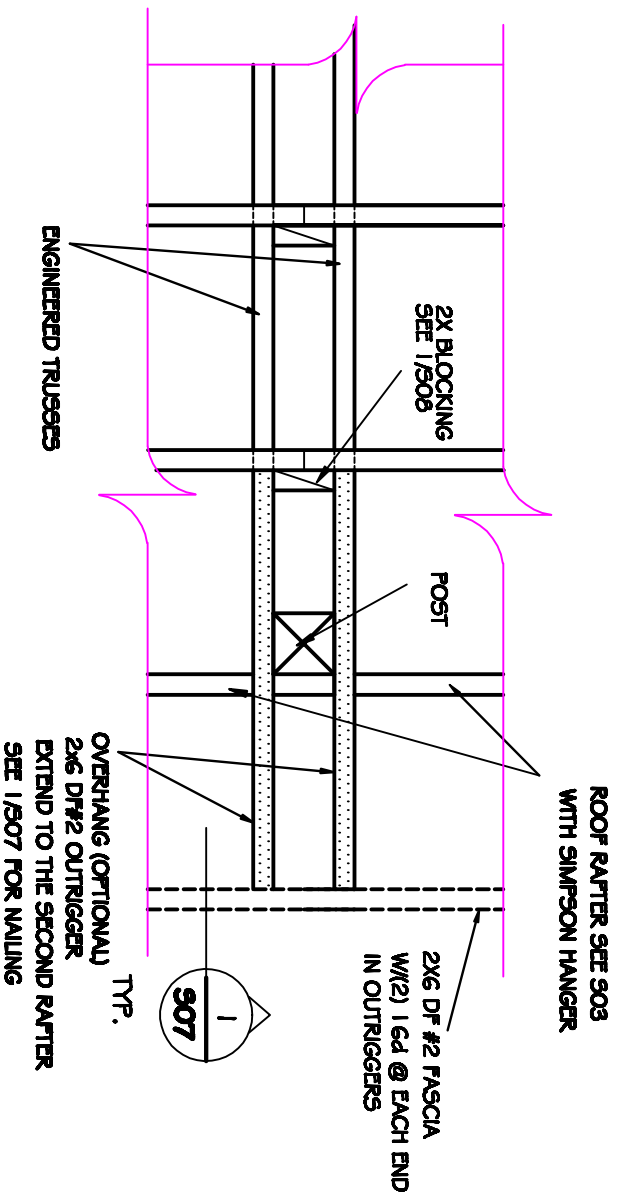

1 OUTRIGGER/OVERHANG DETAIL

509

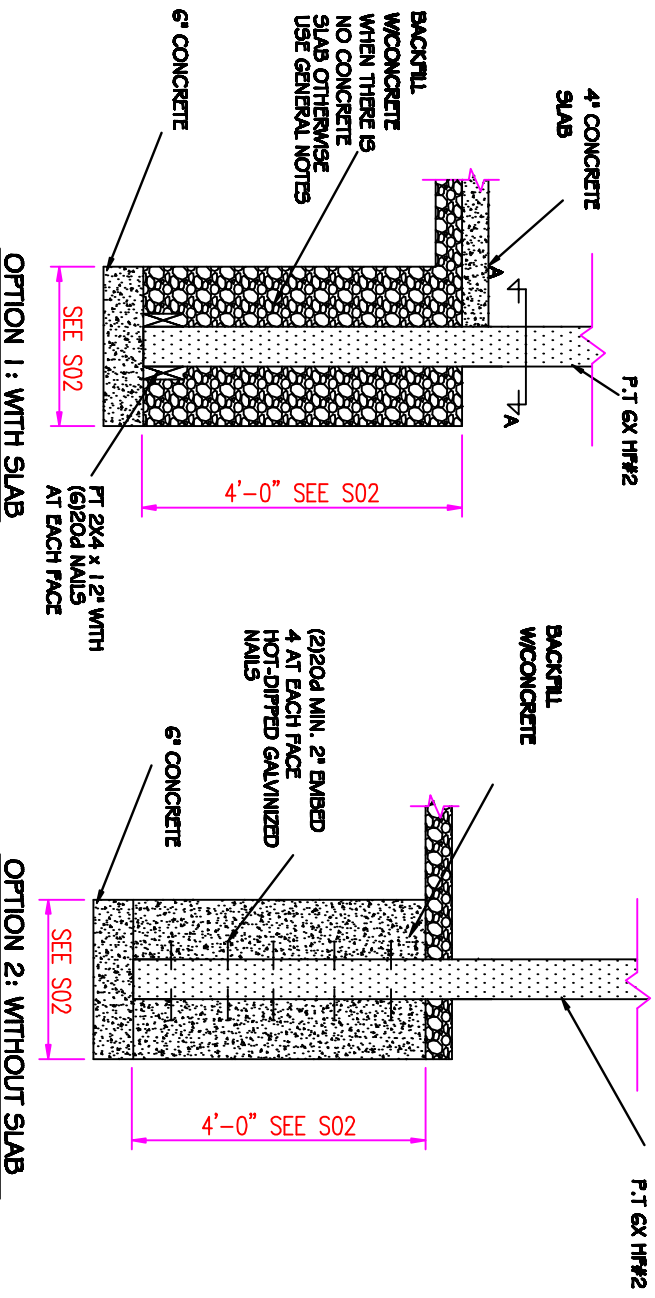
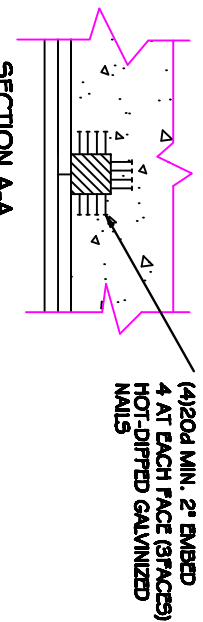

2 FOUNDATION DETAIL

509

BUILDING CODES DIVISION

1535 EDGEWATER STREET NW
SALMON OR 97306
P.O. BOX 14470
TEL: (503) 378-4133 FAX: (503) 378-2322

READY BUILD PLAN #2014-01

PREScriptive POST FRAME BUILDING
24'-0" X24'-0" x 14'-0"
WIND: 95 MPH EXPOSURE "B"
SNOW: 30 PSF

BUILDING CODE:

OSSC: 2010

Sheet:

509

NOTES

1. ALL ROOF AND SIDE, AND GABLE WALL METAL SHEATHING SHALL BE MINIMUM 29 GAGE WITH RIP PATTERN AT 9" INTERVALS FASTEN METAL SHEATHING TO EACH GIRT AND PURLIN AS SHOWN BELOW OR ACCORDING TO THE MANUFACTURER'S RECOMMENDATIONS WHICHEVER IS MORE RESTRICTIVE.
2. BLOCKING IS REQUIRED BETWEEN GIRTS AND PURLINGS IN ORDER TO COMPLY WITH SCREW SPACING AT CORNERS AND OPENINGS.
3. STITCH SCREWS MAY BE USED ON SEAM RID IF DESIRED OR OTHERWISE REQUIRED BY DESIGN (SEE PLANS J), BUT NOT NECESSARY IF WALL AND ROOF PANEL LAPS ARE PLACED IN THE DIRECTION OF PREVAILING WIND.

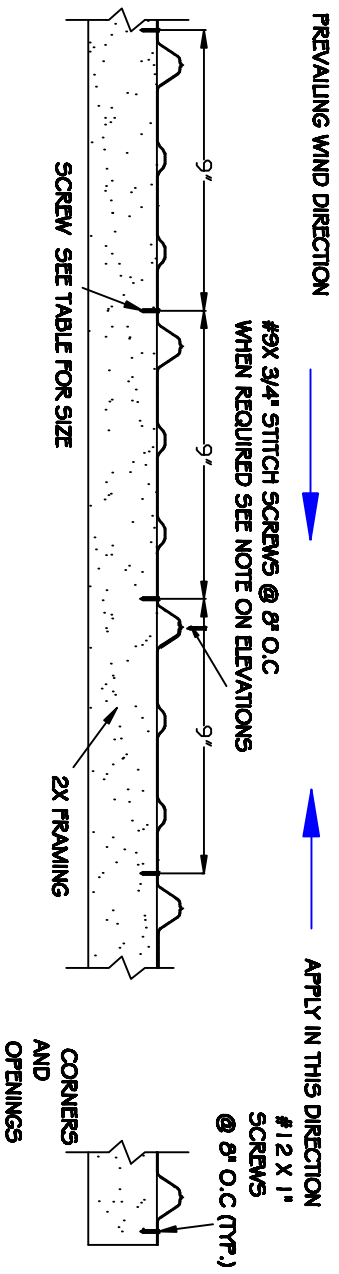

ROOF INTERMEDIATE PURLINS	# 12 X 1" @ 9' O.C
SIDE WALL INTERMEDIATE GIRTS	# 12 X 1" @ 9' O.C
GABLE WALL INTERMEDIATE GIRTS	# 12 X 1" @ 9' O.C

12 X 1"

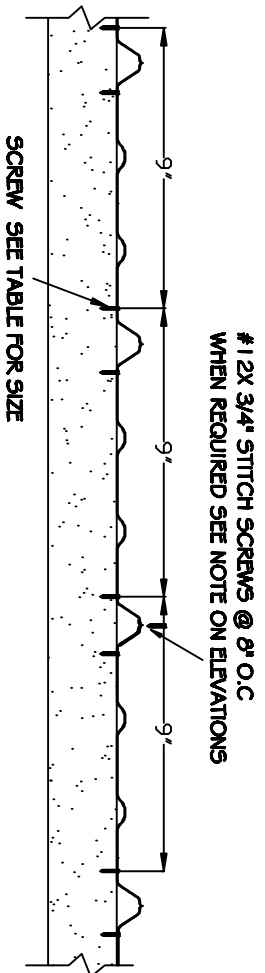

12X 3/4" STITCH SCREWS @ 8" O.C
WHEN REQUIRED SEE NOTE ON ELEVATIONS

SCREWS
@ 8" O.C (TYP.)

BLOCKING
AT GABLE AND WALL
AND OPENINGS

SIDE WALL EAVE AND SPLASH BOARD	# 12 X 1-1/2"
GABLE WALL TRUSS TOP CHORD AND SPLASH BOARD	# 12 X 1-1/2"
RIDGE	# 12 X 1-1/2"

1 S10

WALL AND ROOF SHEATHING FASTENING DETAIL

BUILDING CODES DIVISION

1535 EDGEWATER STREET NW
SALMON OR 97306
P.O. BOX 14470
TEL: (503) 378-4133 FAX: (503) 378-2322

READY BUILD PLAN #2014-01

PRESCRIPTIVE POST FRAME BUILDING
24'-0" X 24'-0" X 14'-0"
WIND: 95 MPH EXPOSURE "B"
SNOW: 30 PSF

BUILDING CODE:

OSSC:2010

Sheets

S10

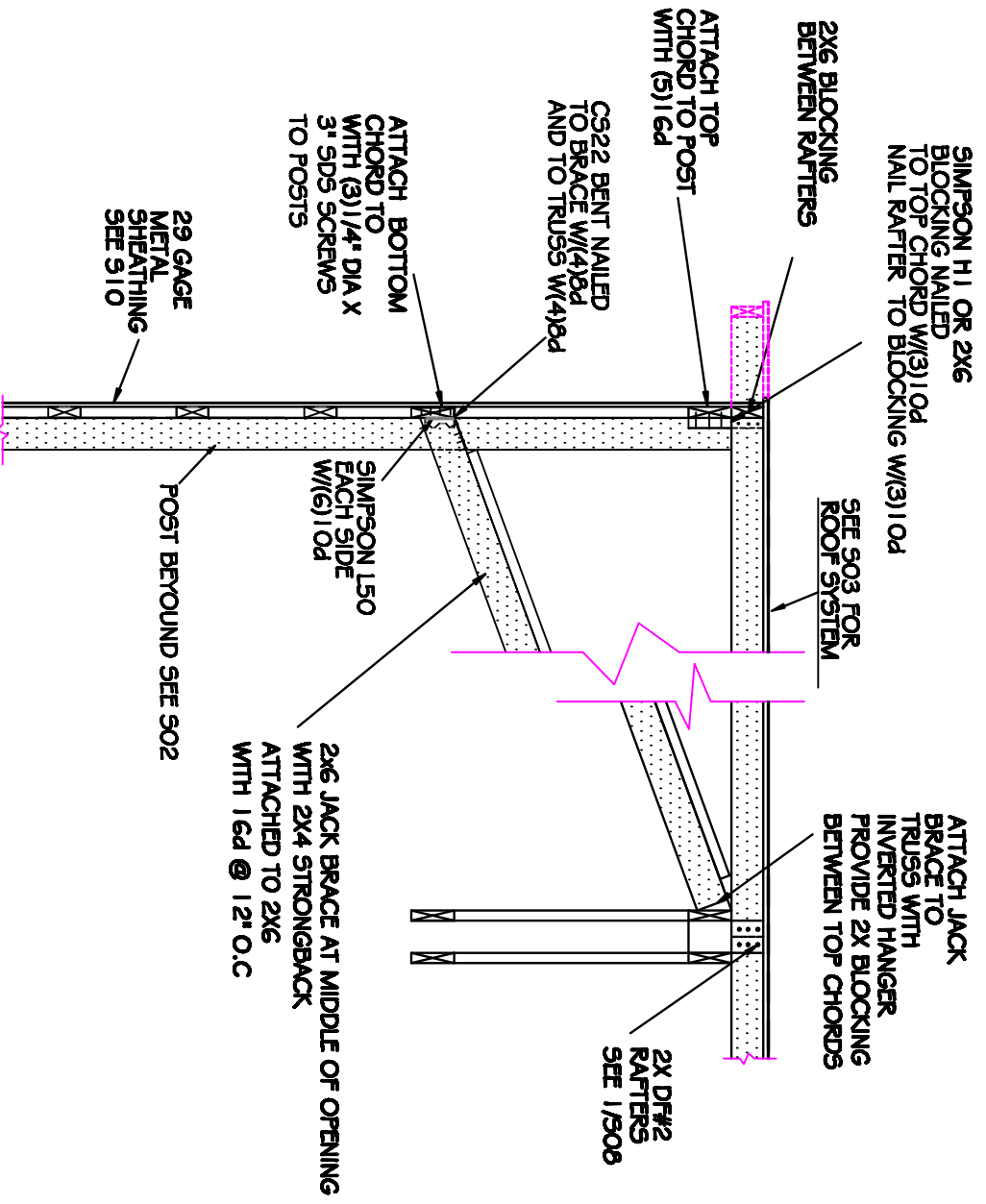

1
511

GABLE TRUSS OUT OF PLANE BRACING

BUILDING CODES DIVISION

1535 EDGEWATER STREET NW
 SALEM OR 97306
 P.O. BOX 14470
 TEL: (503) 378-4133 FAX: (503) 378-2322

READY BUILD PLAN #2014-01
 PRESCRIPTIVE POST FRAME BUILDING

24'-0" X 24'-0" X 14'-0"
 WIND: 95 MPH EXPOSURE "B"
 SNOW: 30 PSF

BUILDING CODE:

OS5C: 2010

Sheets:

S11

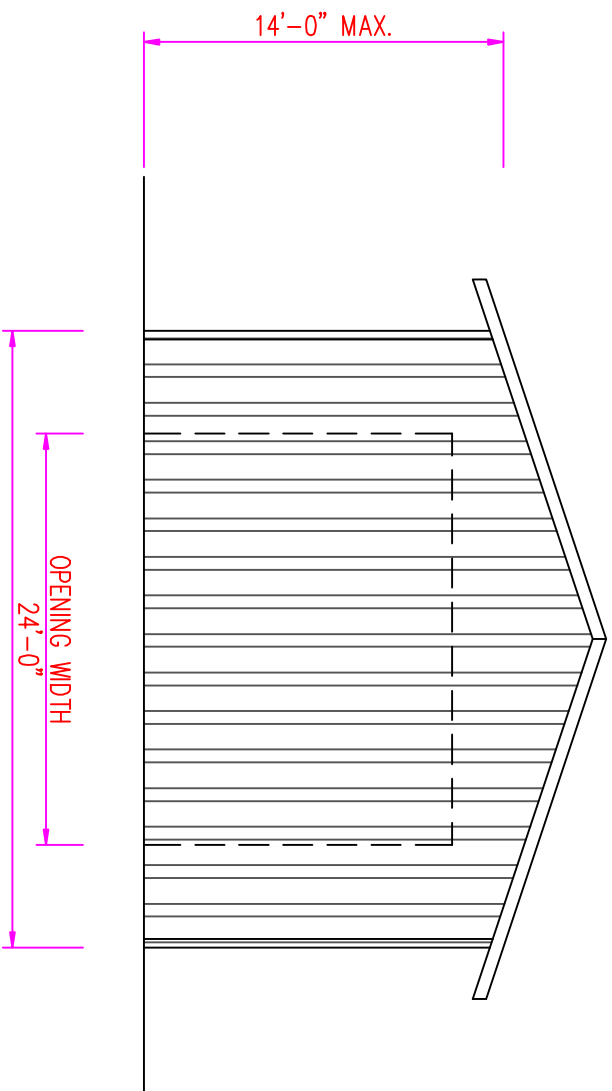

1
S12 GABLE ELEVATION

PLAN NOTES:

1. MAXIMUM OPENING WIDTH IS 16'-0"
2. SEE 1/5 I FOR TRUSS BOTTOM CHORD BRACING FOR OPENING GREATER THAN 14'-0"
3. STITCH WALL PER S10 WHEN OPENING IS GREATER THAN 12'-0"

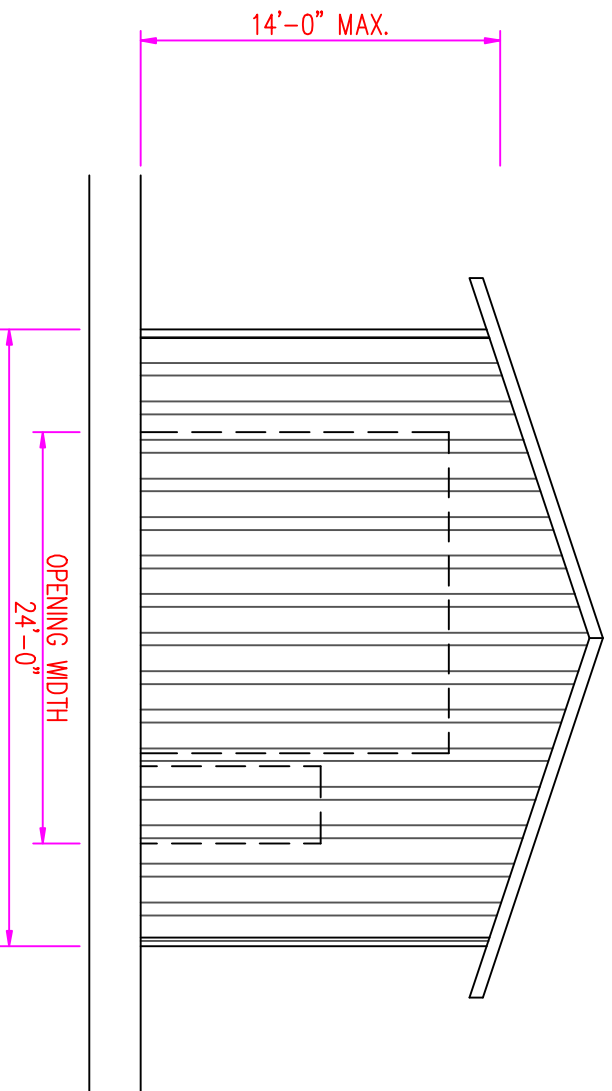

2
S12 GABLE ELEVATION

BUILDING CODES DIVISION

1535 EDGEWATER STREET NW
 SALISBURY OR 97306
 P.O. BOX 14470
 TEL: (503) 378-4133 FAX: (503) 378-2322

READY BUILD PLAN #2014-01
 PRESCRIPTIVE POST FRAME BUILDING

24'-0" X 24'-0" X 14'-0"
 WIND: 95 MPH EXPOSURE "B"
 SNOW: 30 PSF

BUILDING CODE:

OSBC: 2010

Sheets

S12

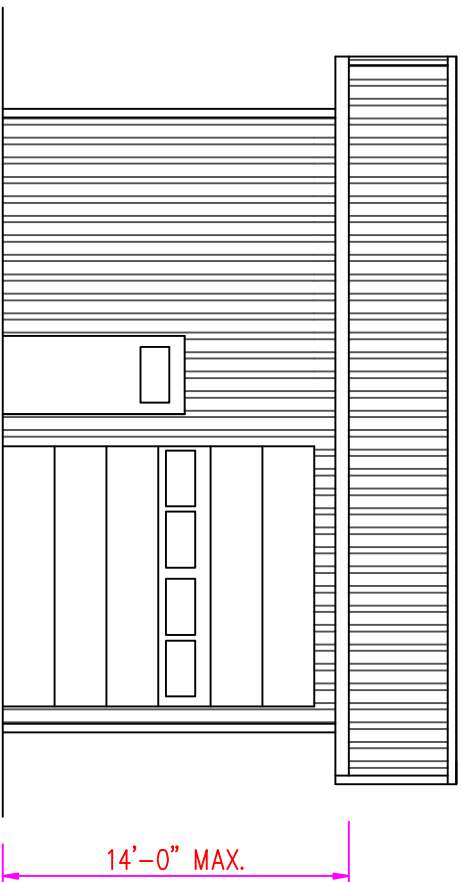

1
S13 SIDE/EAVE ELEVATION

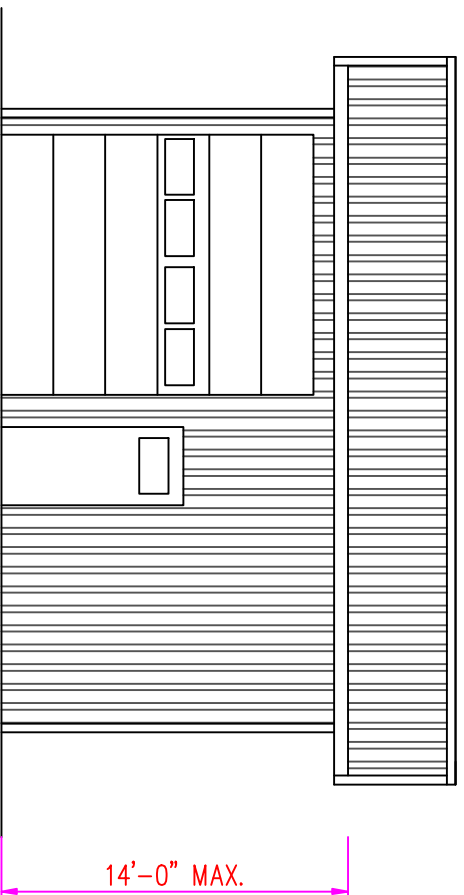

2
S13 SIDE/EAVE ELEVATION

PLAN NOTES:

1. MINIMUM 9'-0" SOLID WALL
2. (4) 10'-0" WIDE OVERHEAD DOORS CAN BE IN THE EAVE WALL
3. STITCH WALL PER S10 WHEN THE SOLID WALL IS 9'-0"

BUILDING CODES DIVISION

1535 EDGEWATER STREET NW
 SALEM OR 97306
 P.O. BOX 14470
 TEL: (503) 378-4133 FAX: (503) 378-2322

READY BUILT PLAN #2014-01
 PRESCRIPTIVE POST FRAME BUILDING

24'-0" X 24'-0" X 14'-0"
 WIND: 95 MPH EXPOSURE "B"
 SNOW: 30 PSF

BUILDING CODE:

OSSC: 2010

Sheet:

S13